

Overview

Mini-Pitch System™ modular sports solution includes everything needed to transform an underutilized area into a fully-equipped soccer pitch. The modular system includes lighting, fencing, goals, benches, ADA-compliant access, and lockable storage.

Features

Structure

- Designed and manufactured as a system
- All components prefabricated for bolt-together construction
- Pitch structure, crossarms, and pole shaft are hot-dip galvanized inside and outside after fabrication to meet ASTM-A123 and EN 1461 standards
- Engineered anchor system and hardware provided — all units are approved for 175 mi/h (78 m/s) winds without signage, 120 mi/h (54 m/s) with signage
- ADA compliant entry points with latching gates provided on each side of pitch
- Seating, cupholders, and 20 ft³ (0.566 m³) of lockable storage incorporated in structure

Lighting

- Designed and manufactured as a system including TLC for LED® luminaires, structural components, and complete electrical system including grounding and surge suppression
- All luminaires and electrical components enclosures factory assembled, aimed, wired, and tested
- Luminaires and mounting components withstand up to 150 mi/h (67 m/s) windspeed without misalignment

Control-Link® Service

- Instant on/off control or scheduled operation up to 10 years in advance
- Control-Link Central™ service center provides scheduling and support 24 hours a day, 7 days a week
- Customized usage reports through website

Warranty and Support

- 10-year warranty covers the complete system so your pitch is always ready for play

Technical Specifications

Goals

Net material 0.19 in (4 mm) galvanized chain link
 Frame construction 0.12 in (3 mm) hot-dip galvanized steel tubing and channel
 Panel material 0.105 in (2.67 mm) powder-coated galvanized steel plate

Structure

Frame material 2 in (50 mm) square steel tube
 Picket material 0.12 in (3 mm) steel channel
 Cabinet material 0.105 in (2.67 mm) steel plate
 Finish Hot-dip galvanized
 Construction Prefabricated sections bolt-together assembly
 Bench dimensions 11.5 in (292 mm) x 4 ft (1.22 m)
Bench quantity varies see pitch configurations for details
 Bench material 0.078 in (1.98 mm) anodized aluminum
 Lockable storage capacity 20 ft³ (0.566 m³)
 Wind speed rating (structure) 175 mi/h (78 m/s)
 IBC 2015 exposure C
 120 mi/h (54 m/s) with signage

Anchor System

Concrete Surface
 Anchor type 5.5 in (140 mm) galvanized wedge
 Pull rating per anchor 2000 lb (907 kg)
 Asphalt Surface
 Anchor type 12 in (305 mm) grout embedded
 Pull rating per anchor 2999 lb (1360 kg)

Lighting

Luminaires per pitch Qty 2 TLC-LED-550
See luminaire datasheet for details
 Aiming Factory aimed 0.2° accuracy
 Wind speed rating (aiming only) 150 mi/h (67 m/s)
 Pole and crossarm material Hot-dip galvanized steel
 Lifting eye Integral
 Pole support Anchored frame structure
 Wind speed rating (pole) 175 mi/h (78 m/s)
 IBC 2015 exposure C

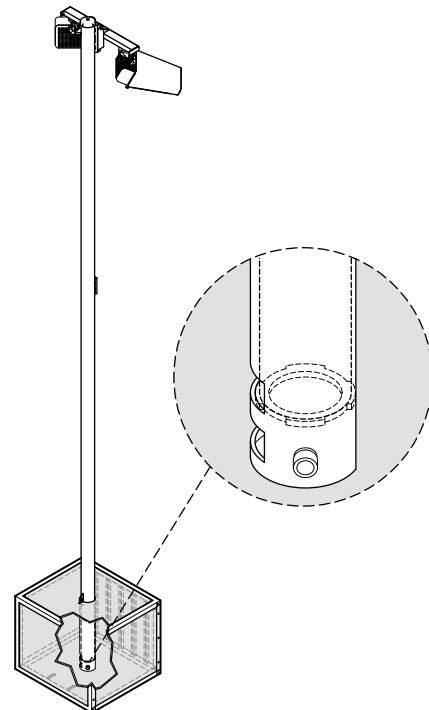
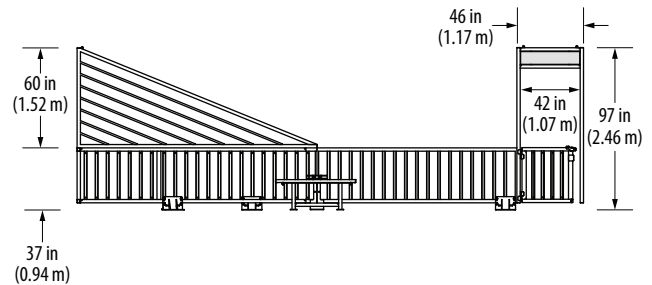
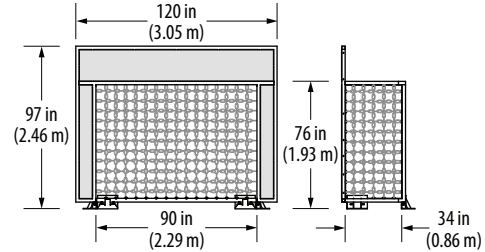

Datasheet: Mini-Pitch System™ Modular Sports Solution

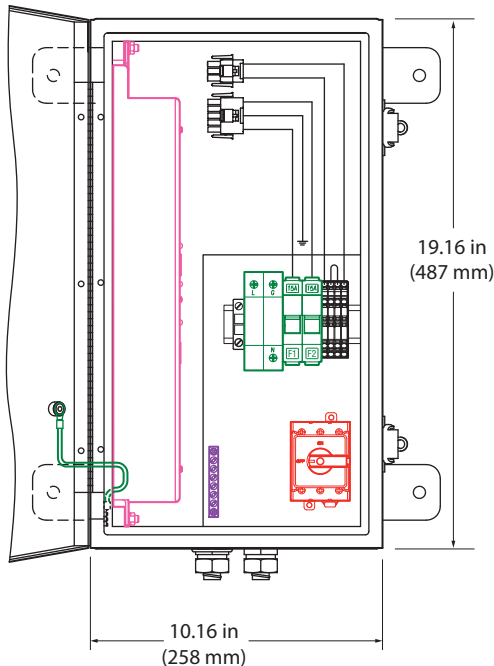
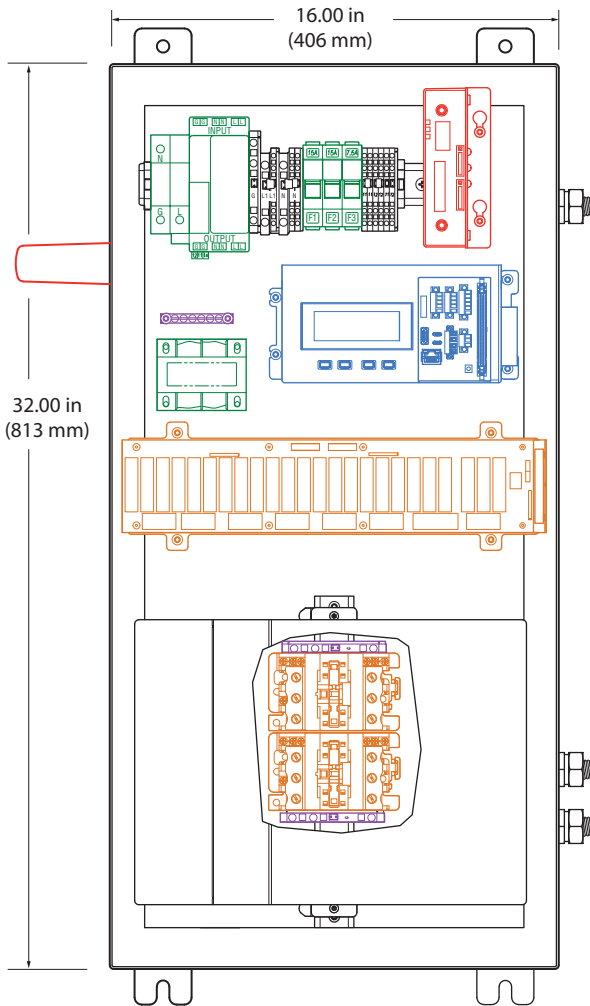

Control-Link® Control System and Electrical Components Enclosure

- Factory wired, programmed, and tested
- Internally fused
- Control power terminal blocks provided

Control Module

Receives and stores schedules from Control-Link Central™ service center, operates your equipment, and verifies schedules are carried out.

- Executes scheduled on/off events
- Stores schedules for up to 7 days
- Automatic recovery mode to current lighting schedule in the event of power interruption or loss

Communication Modules

Communication with Control-Link Central via integrated, high speed, cellular connection with no additional monthly charges during the warranty period.

I/O Board and Contactor Modules

Switches equipment based on control module schedules.

- Compliant with IEC 60947-4-1 for continuous operation at 100% of rated current
- Contactors rated for 30 A

Circuit Protection

- 50kA Surge protection
- Internally fused

Ground Bar

Provides integral ground bar for lighting equipment grounding.

Remote Driver

- Easy access for maintenance
- Isolated from luminaires for improved thermal performance

Disconnect Switch

- Disconnects power at electrical components enclosure
- Supports lock-out/tag-out procedures

Datasheet: Mini-Pitch System™ Modular Sports Solution

Pitch Configurations

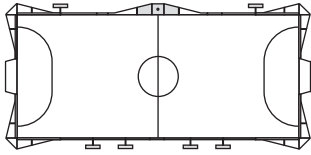

40 ft x 84 ft
12 m x 25 m

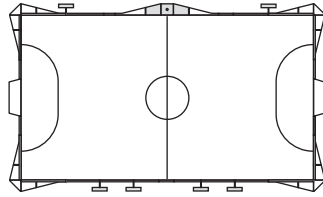

50 ft x 84 ft
15 m x 25 m

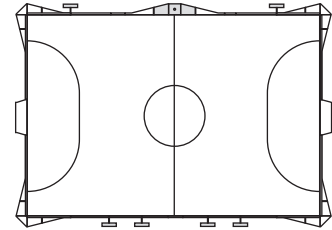

60 ft x 84 ft
18 m x 25 m

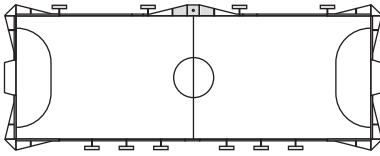

40 ft x 104 ft
12 m x 32 m

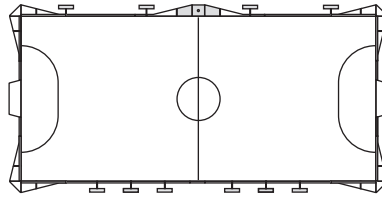

50 ft x 104 ft
15 m x 32 m

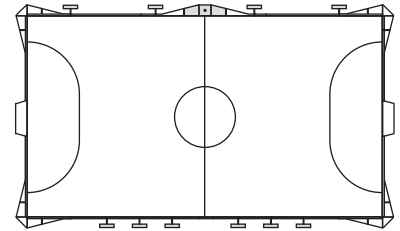

60 ft x 104 ft
18 m x 32 m

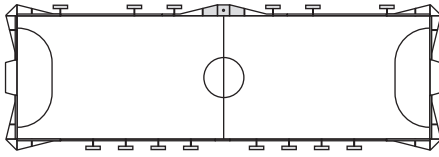

40 ft x 120 ft
12 m x 36 m

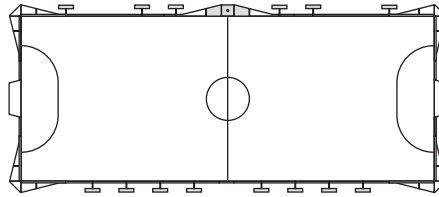

50 ft x 120 ft
15 m x 36 m

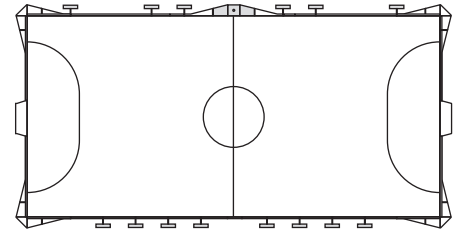

60 ft x 120 ft
18 m x 36 m

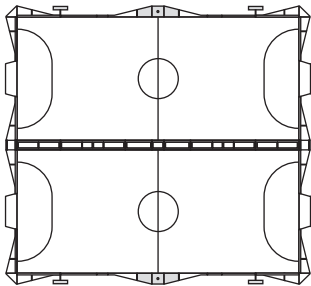

76 ft x 84 ft
23 m x 25 m

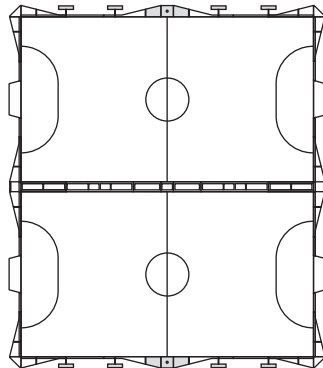

96 ft x 104 ft
29 m x 32 m

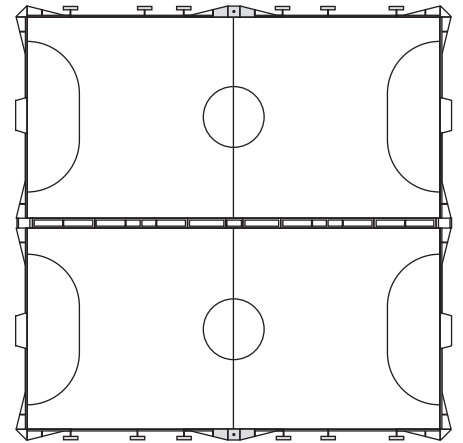

116 ft x 120 ft
35 m x 36 m

*Note: Double pitch available in all optional sizes.